

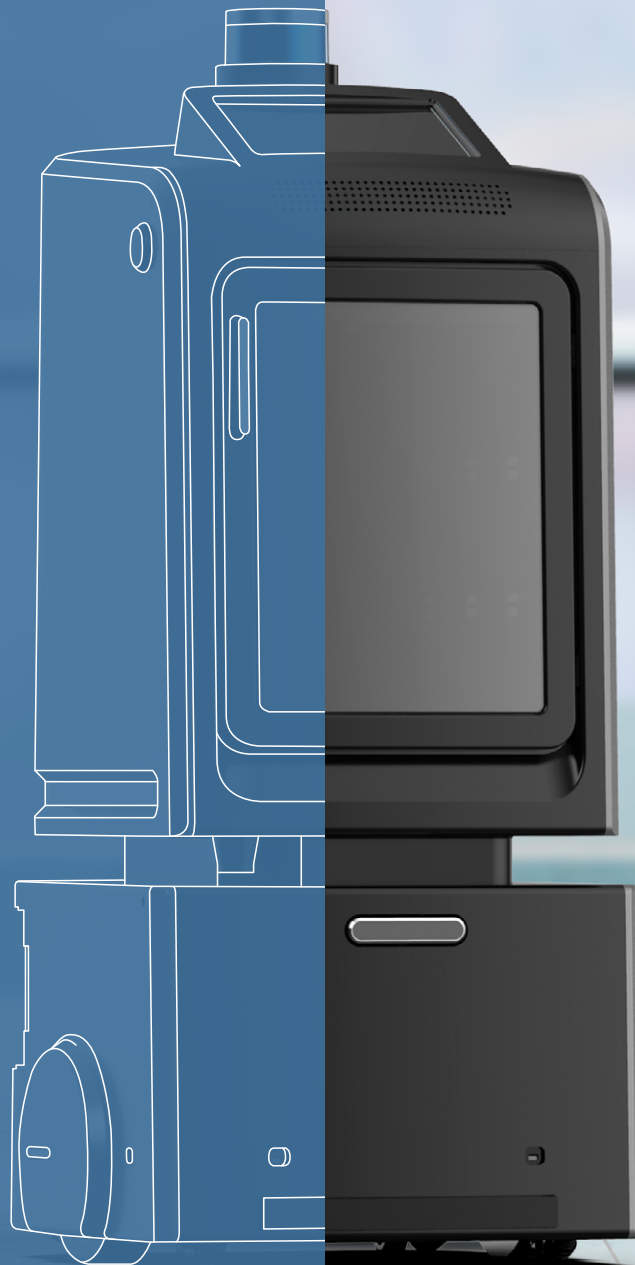

# SUNBO ROBOTICS Autonomous Logistics Robot



# NarGo Order Picking

Use autonomous logistics robots for transportation and delegate internal logistics center tasks, like order picking, to them. This improves logistics warehouse efficiency and reduces operational cost.

✔ **No issue operating with layout changes**

It operates fully self-driving without the need for additional infrastructure.

✔ **An 80% reduction in order picking labor expenses.**

This reduction has resulted in decreased labor costs and reduced expenditures on various tools such as PDAs, order lists, and carts.

✔ **Efficient operation**

Increased picker accuracy by minimizing omissions and incorrect picks, and achieved flexible operation with varying numbers of robots.

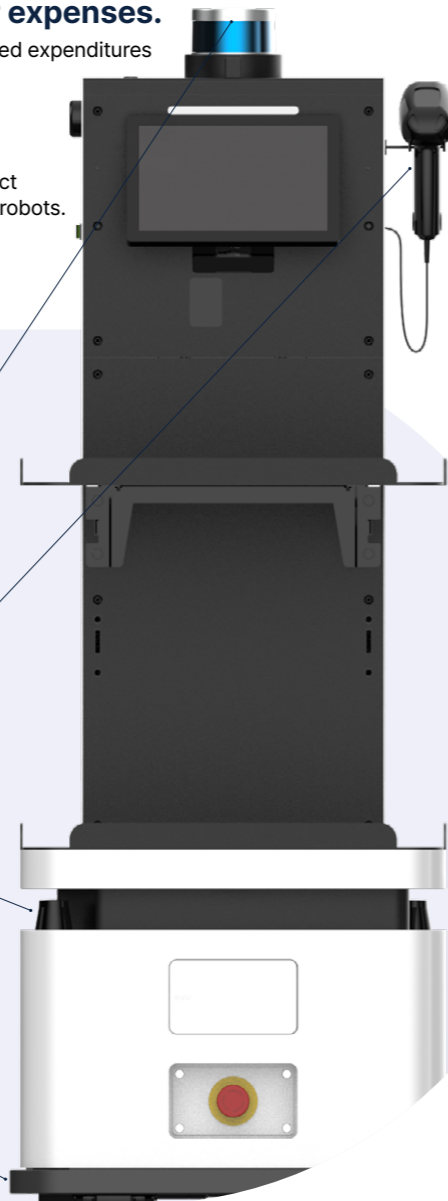

### 3D LiDAR

The 3D LiDAR detection ranges are ±15° and 360°. It enables a robot to perform self-localization and detect the movement of obstacles for planning safe movement.

### Barcode reader

A device, available in both handheld and integrated forms, designed to capture barcode information from products.

### 2D LiDAR

The two 2D LiDARs cover 360° surroundings to detect the movement of obstacles for keeping a high level of safety.

### Bumper

An emergency stop mechanism is in place by receiving signals from the bumper.

## Usage Scenarios



1. Receive task information and assign robots



2. Upon order information recognition, proceed to the designated storage location for the items.



3. After the picking operator picks up and scans the items, they proceed with the item loading process.

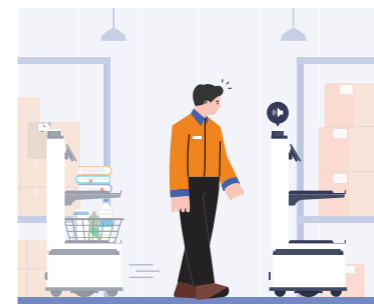

4. After finishing loading, the robot relocates to the packaging station, while the operator repeatedly carries out product picking tasks.

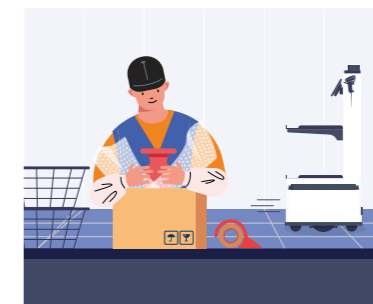

5. Upon the robot's arrival at the packaging station, the packing operator verifies the items, completes the packaging process, and proceeds to shipment.



6. Once the robot unloads the items at the packing zone, it either proceeds with repetitive tasks or moves to the charging station.

## Specification



Basic Specification			
Size (LWH)	696 × 546 × 1,509 mm	Shelf Size (LW)	500 × 509 mm
Max. Speed	Max. 1.5 m/s	Payload	100 kg (The rest of shelves carries 20 kg and above)
Operating Humidity	Under relative humidity 80%	Network	Wi-Fi, LTE
Operating Illumination	100 ~ 1000 lx	Operating Environment Temperature	0~40 °C

Battery & Motion Performance			
Power Consumption	25.2 V, 54 Ah	Charging Method	Automatic charge / Manual charge
Charging Hours	Under 3hrs	Operating Hours	Max. 8hrs
Step / Gap	±10 mm / 35 mm	Max. Gradability	5°

Safety Device	
Sensor	3D LiDAR (Environmental information recognition) 2D LiDAR (360° omnidirectional obstacle detection) Bumper (Collision detection)

# NarGo Delivery

Do not make any further efforts for deliveries of food, mail, parcels, and other items within high-rise buildings and residential areas. An autonomous logistics robot transports the goods directly to your precise location.

## ✓ Elimination of repetitive mobile tasks

Efficient time utilization by having robots replace basic mobility tasks.

## ✓ Full contactless delivery

Enhancing security, safety, and psychological comfort through full contactless delivery.

## ✓ Enhancement of corporate image

Become a leader of the times with a high-tech image that enhances your corporate reputation.

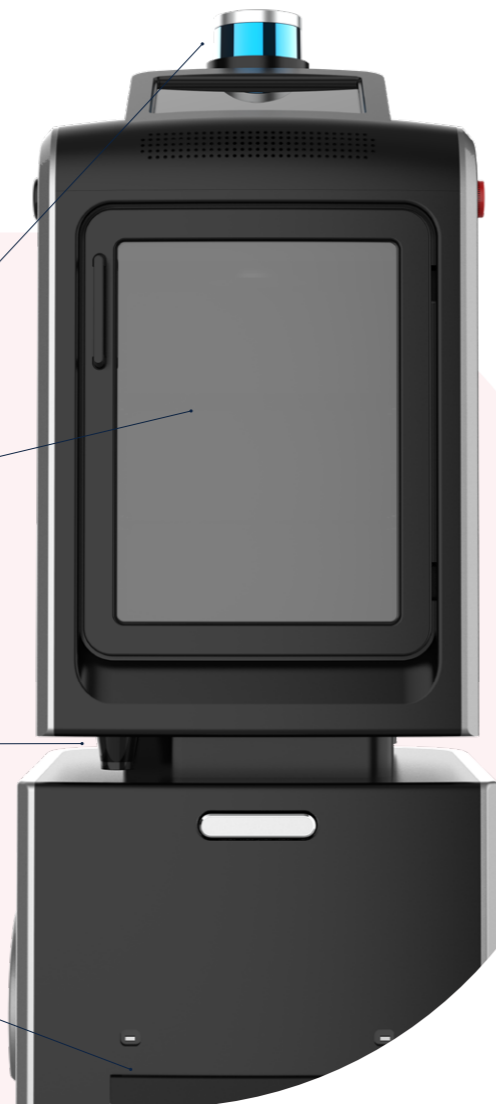

### 3D LiDAR

The 3D LiDAR detection ranges are  $\pm 15^\circ$  and  $360^\circ$ . It enables a robot to perform self-localization and detect the movement of obstacles for planning safe movement.

### Cargo box

The loading area for delivery goods (Maximum load capacity: 30 kg)

### 2D LiDAR

The two 2D LiDARs cover  $360^\circ$  surroundings to detect the movement of obstacles for keeping a high level of safety.

### Bumper

An emergency stop mechanism is in place by receiving signals from the bumper.

## Usage Scenarios



1. Order goods

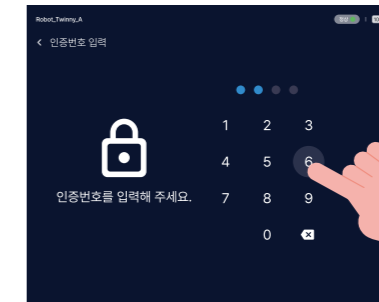

2. Enter customer details



3. Load items



4. Transport goods

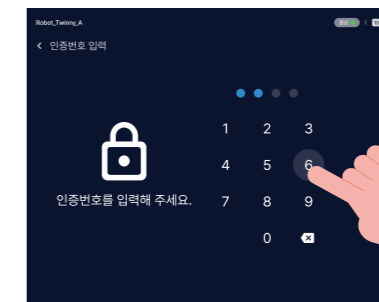

5. Verify customer details



6. Customer picks up the item

## Specification

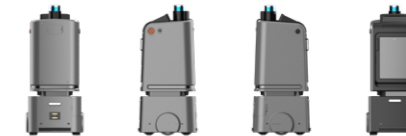

### Basic Specification

Size (LWH)	560 × 540 × 1,220 mm	Stowage (LWH)	340 × 308 × 410 mm
Max. Speed	Max. 1.0 m/s	Payload	30 kg
Operating Humidity	Under relative humidity 80%	Network	Wi-Fi, LTE
Operating Illumination	100 lx or more, 1000 xl or less at 1 m above the floor	Operating Environment Temperature	0~40 °C

### Battery & Motion Performance

Power Consumption	25.2 V, 54 Ah	Charging Method	Automatic charge / Manual charge
Charging Hours	Under 3hrs	Operating Hours	Max. 8hrs
Step / Gap	$\pm 20$ mm / 30 mm	Max. Gradability	5°

### Safety Device

Sensor	3D LiDAR (Environmental information recognition) 2D LiDAR (360° omnidirectional obstacle detection) Bumper (Collision detection)
--------	--

# NarGo Factory

Explore the adoption of robotics, arms, conveyors, lifts, or any other form, tailored to fit seamlessly into your factory.  
Taking the first step in factory automation is not challenging.

- ✓ **Site-specific customization**  
 Factory automation boosts operational efficiency and offers the flexibility to attach accessories as needed.
- ✓ **Achieving a 70% reduction in labor expenses**  
 Cost savings in labor and consumable expenditures for operations
- ✓ **Ensuring safety and security**  
 Creating a secure workplace by decreasing incidents involving workers and forklifts.

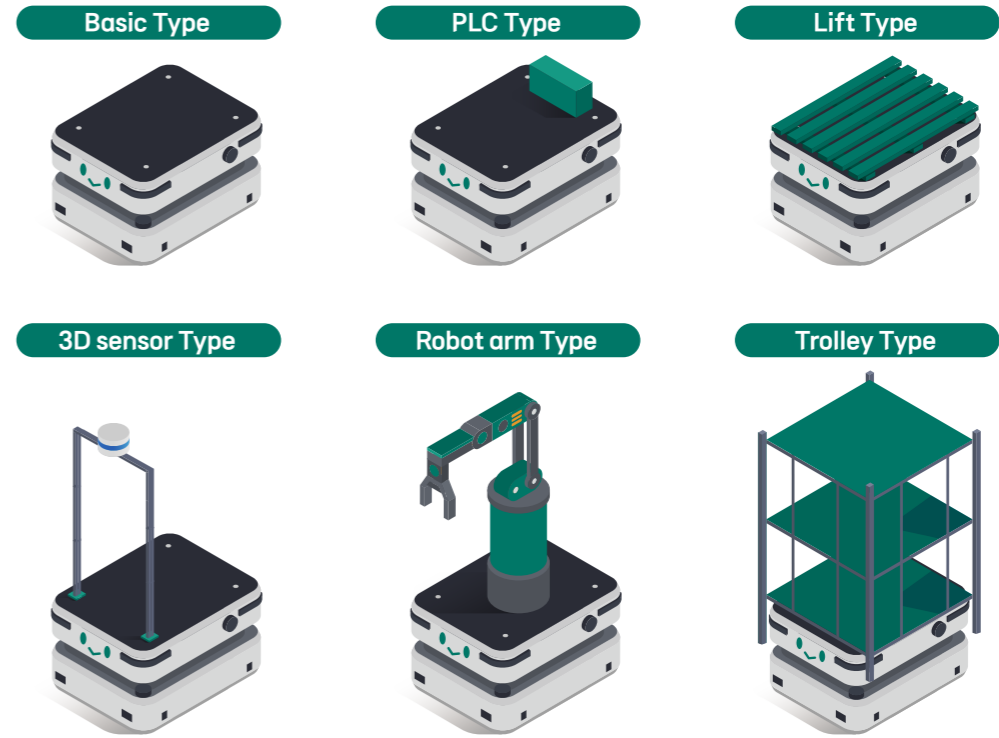

## PLC

Seamlessly integrate a variety of accessories and control devices such as conveyors and lifts for added convenience.

## 2D LiDAR

The two 2D LiDARs cover 360° surroundings to detect the movement of obstacles for keeping a high level of safety.

## Bumper

An emergency stop mechanism is in place by receiving signals from the bumper.

## ToF sensor

Detection of blind spots using 2D LiDAR sensors

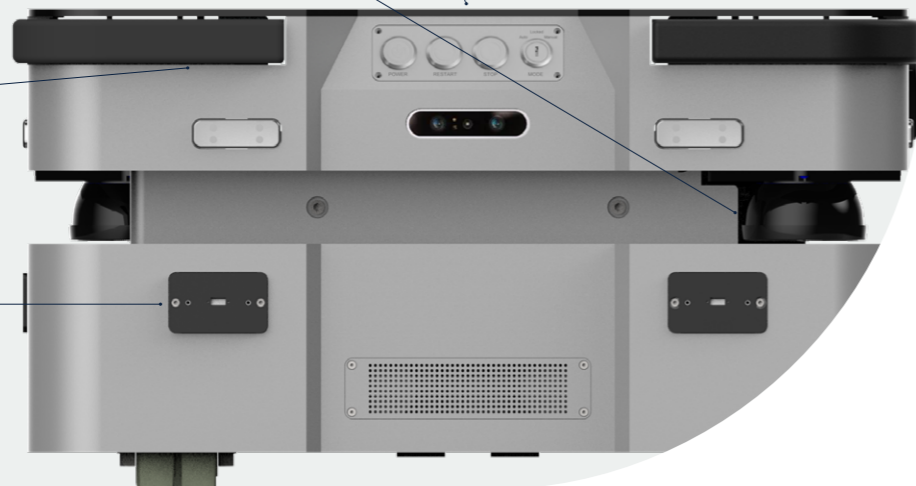

## Specification



Basic Specification			
Size (LWH)	622 × 820 × 330 mm	Max. Speed	1.5 m/s
Payload	Max. 300 kg	Operating Humidity	Under relative humidity 80%
Operating Illumination	100 ~ 1000 lx	Operating Environment Temperature	5~40 °C
Network	Wi-Fi 2.4GHz 802.11 g/n, 5GHz 802.11 a/n		
Battery & Motion Performance			
Power Consumption	Li-ion Battery, 50.4V-36.0Ah	Charging Method	Automatic charge / Manual charge
Charging Hours	Under 3hrs	Operating Hours	Max. 8hrs
Step / Gap	±6 mm / 30 mm	Max. Gradability	5°
Safety Device			
Sensor	2D LiDAR (360° omnidirectional obstacle detection) Bumper (Collision detection) ToF sensor		
Specialized Safety Functions	Protective Halt (PLd)		
Miscellaneous Equipment			
MITSUBISHI PLC			

# NarGo Series

**NarGo60 and NarGo100** autonomous logistics robots that can be used anywhere, depending on the space size. **NarGo500**, an autonomous logistics robot capable of collaborating with forklifts in a factory.

## Common Features

- Gradability upto 5°
- Various customized design available
- Stable self-localization regardless of the space size and the population density
- Easy operation using the control system

## NarGo60 & NarGo100 Features

- Ability to take an elevator
- Ability to connect with an automatic door

## NarGo500 Features

- Ability to collaborate with forklifts / pallet (loading - unloading station)
- Higher level systems integration available
- Various pallet types available

### 3D LiDAR

The 3D LiDAR detection ranges are ±15° and 360°. It enables a robot to perform self-localization and detect the movement of obstacles for planning safe movement.

### Lift

Capability for loading/unloading pallets

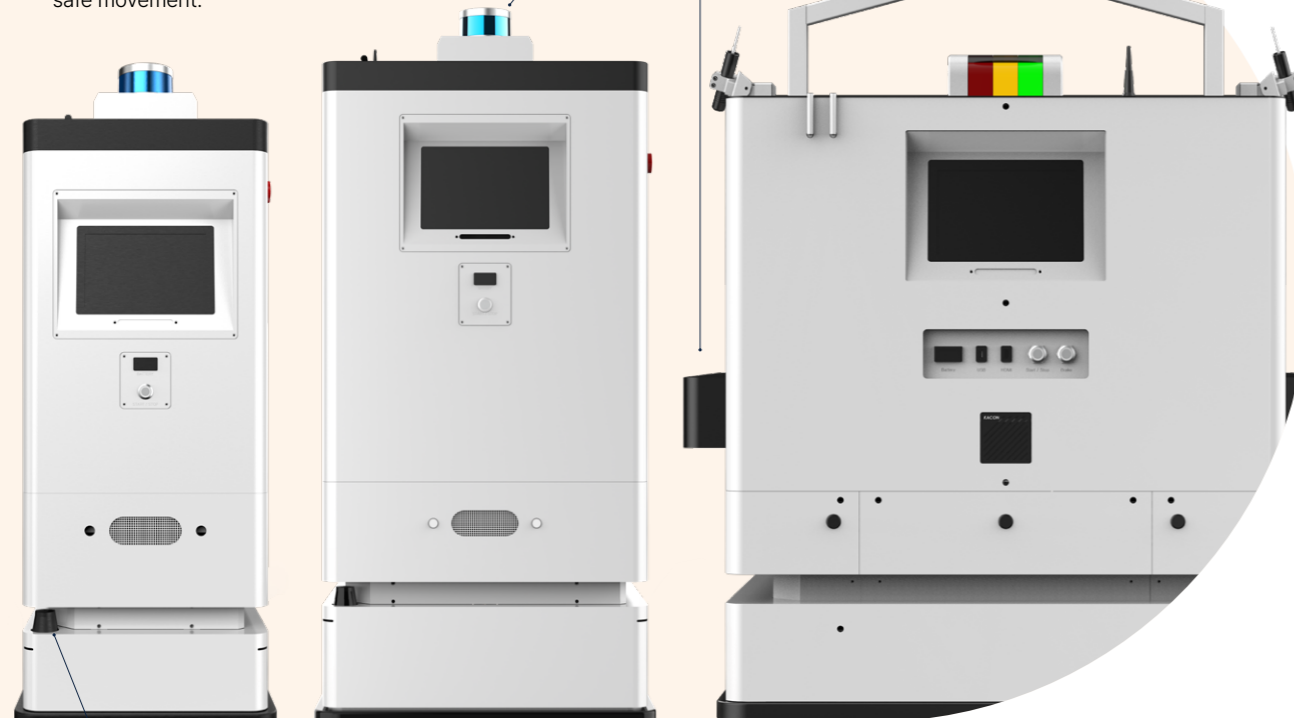

### 2D LiDAR

The two 2D LiDARs cover 360° surroundings to detect the movement of obstacles for keeping a high level of safety.

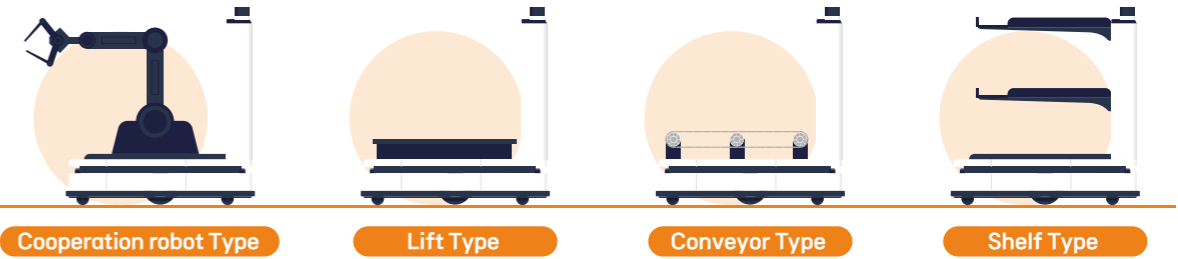

## Specification



NarGo60			
Size (LWH)	736 × 477 × 1,247 mm	Cargo Box Size (LWH)	560 × 446 × 670 mm
Max. Speed	Max. 1.2 m/s	Payload	60 kg
Network	Wi-Fi, LTE	Operating Environment Temperature	5~40 °C
Charging Hours	Under 3hrs	Operating Hours	Max. 20hrs



NarGo100			
Size (LWH)	916 × 667 × 1,446 mm	Cargo Box Size (LWH)	740 × 640 × 810 mm
Max. Speed	Max. 1.2 m/s	Payload	100 kg
Network	Wi-Fi, LTE	Operating Environment Temperature	5~40 °C
Charging Hours	Under 2hrs	Operating Hours	Max. 17hrs

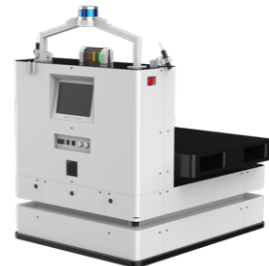

NarGo500	
Size (LWH)	1,384 × 1,064 × 1,373 mm
Applicable Pallet Size (LWH)	1,100 × 740 × 140 mm
Max. Speed	Max. 1.0 m/s
Payload	500 kg
Network	Wi-Fi, LTE
Operating Environment Temperature	5~40 °C
Charging Hours	Under 2hrs
Operating Hours	Max. 16hrs



NarGo500 Pallet holder	
Size (LWH)	750 × 1,200 × 550 mm
Payload	Max. 600 kg

# TarGo Series

One second, one touch is enough with target following robot **TarGo60 & TarGo100**

## Common Features

- Robust target following technology without any additional device
- Follow the target through size, color, motion and location information
- Easy operation for anyone to use
- Triple safety system equipped with RGBD camera, Laser distance measurement sensor, and Ultrasonic sensor
- Customization available

### RGBD camera

Tracking the location and movements of the followed target.



### 2D LiDAR

The two 2D LiDARs cover 360° surroundings to detect the movement of obstacles for keeping a high level of safety.

### Ultrasonic sensor

## Safety



### Target recognition using a RGBD camera

Trajectory planning that leads safe and precise movement.



### Environment recognition using 2D LiDAR sensors

The two 2D LiDARs cover 360° surroundings to detect movement of obstacles for keeping high-level of safety.



### Emergency stop using bumper and pressure sensor

Emergency stop mechanism is in placed by receiving signal from the bumper.

## Specification



### TarGo60

Size (LWH)	900 × 540 × 1,300 mm	Cargo Box Size (LWH)	670 × 489 × 800 mm
Max. Speed	Max. 1.0 m/s	Payload	60 kg
Charging Hours	Under 1hrs	Operatating Hours	Max. 7hrs
Operating Environment Temperature	5~40 °C		



### TarGo100

Size (LWH)	975 × 690 × 1,288 mm	Cargo Box Size (LWH)	740 × 625 × 797 mm
Max. Speed	Max. 1.0 m/s	Payload	100 kg
Charging Hours	Under 2hrs	Operatating Hours	Max. 15hrs
Operating Environment Temperature	10~35 °C		

An autonomous mobile robot that emulates human thinking and movement

## How can I assist you?

Conversational AI-driven Autonomous Mobile Robot

# Chatty NarGo



A combination of conversational AI technology (Large Language Model) and autonomous driving technology

### ✔ Competitive edges of SUNBO ROBOTICS robot

- Ability to operate with reliable navigation even in large and complex environments such as department stores
- Ability to determine self-location and provide relevant location information followed by guidance to the location



### Voice recognition operation

No device manipulation is required. Operate through voice recognition for convenient operation.



### Interactive commands

Commands are given through natural conversation as if talking to a person ("My legs hurt" → guidance/movement to a rest area, "I'm hungry" → guidance/movement to a restaurant)



### Handling unstructured questions

Possibility to answer unstructured questions ("Tell me a good golf wear store," "Tell me a restaurant where I can eat for less than \$10", etc.)



### Real-time companion

Accompanying partner to your journey to guide you with directions



### Provision of location information

Possibility to answer specific questions about the venues (introduction of Now-Showing movie, show time, and ticket prices, etc.)









**SUNBO ROBOTICS**  
선보로보틱스



[sunborobotics.ai](http://sunborobotics.ai)



[salescontact@twinny.ai](mailto:salescontact@twinny.ai)



(Head office) 90, Gajeongbuk-ro, Yuseong-gu,  
Daejeon, Republic of Korea

(Bundang branch) 5F 510, 34, Hwangsaetul-  
ro 200beon-gil, Bundang-gu, Seongnam-si,  
Gyeonggi-do, Republic of Korea



(Head office) +82 42. 716. 1558

(Sales team) +82 42. 866. 8230

(Bundang branch) +82 70. 7734. 0909

